

ED100/ED250

Automatic Swing Door Operators
Installation in Surface Applied Header

Owner's Manual

DL4614-030 – 08-2018

| EN |

dormakaba 

Table of contents

Table of contents	2
1 General information	3
2 To our customers	3
3 What you should know	4
3.1 Distributor information	4
3.2 Knowing act	4
3.3 Low energy power operated door	4
3.4 Program switch panel	4
3.5 Optional key switch panels	4
4 AAADM Safety information labels	5
4.1 Safety label, automatic swinging doors	5
4.2 Safety label, low energy swinging doors	5
5 Daily safety check procedure	6
5.1 Power operated swing doors	6
5.2 Low energy power operated swing doors	7
6 General safety related items	8
6.1 Power operated swing doors	8
6.2 Low energy power operated swing doors	9
7.1 Full energy operator	10
7.2 Low energy operator	10
7.3 Door signage, full energy single swing door	11
7.4 Door signage, low energy single swing door	11
7.5 Door signage, full energy double swing doors	12
7.6 Door signage, low energy double swing doors	14
8 ED100/ED250 header cleaning	15
8.1 ED100/ED250 environment and cleaning	15

1 General information

1.1 Owner's Manual

This Owner's manual applies to the following dormakaba USA Inc. automatic swing door operators packaged in a surface applied header:

1. ED100 low energy/power operated pedestrian operator.
2. ED250 power operated/low energy pedestrian operator.

1.2 Manual storage

This document must be kept in a secure place, and accessible for reference as required. If the door system should be transferred to another facility, insure that this document is transferred as well.

1.3 dormakaba.com website

Manuals are available for review, download, and printing on dormakaba.com website.

1.4 Dimensions

Unless otherwise specified, all dimensions are given in inches (").

1.5 Symbols used in this manual.



WARNING

This symbol warns of hazards which could result in personal injury or threat to health.

1.6 Surface applied (SA) header and ED100/ED250 operator.

Fig.2.1 ED100/ED250 surface applied header

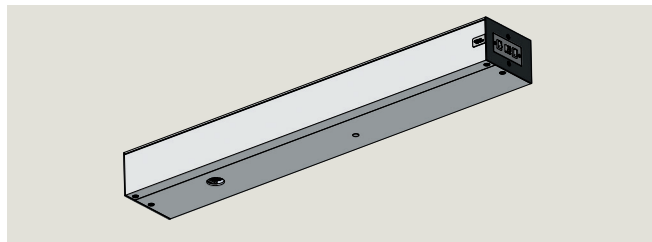

Fig.2.2 ED100/ED250 operator



2 To our customers

We are pleased that a dormakaba USA, Inc. ED100/ED250 automatic swing door system has been selected for this installation. dormakaba, USA Inc. designed, tested and built the system to provide many years of service.

The purpose of this manual is to familiarize you with your ED100 or ED250 automatic swing door system.

It is essential that you "know your system" and that you recognize the importance of maintaining your door system in compliance with industry standards for safety.

It is your responsibility as owner and caretaker of the equipment, to inspect the operation of your door system on a daily basis as outlined in Chapter 4, Safety information checklist to insure that it is safe for use by your customers and employees.



WARNING

Should the door fail to operate as prescribed in the Safety information checklist or at any other time for any reason, do not attempt to repair or adjust the ED100/ED250 automatic swing door system!

Call your local authorized dormakaba USA, Inc. distributor for repair. The distributor's AAADM certified technicians are trained to service the ED100/ED250 automatic swing door system using the dormakaba USA, Inc. Installation and Service Manuals, and in accordance with ANSI/BHMA safety standards.

2.1 Service availability.

dormakaba USA, Inc. has a nationwide network of authorized distributors for sales, installation and service of its products.

2.2 Compliance with industry standards for safety.

Your ED100/ED250 automatic swing door system was designed to the latest ANSI/BHMA operating and safety standards. In order to insure the continued safe operation of the door, it is important that:

- Proper decals and labels be applied and maintained on your doors (Chapter 7).
- If decals and labels have been removed, or cannot be read, contact your local authorized dormakaba USA, Inc. distributor for replacement decals or labels.

3 What you should know

3.1 Distributor information

3.1.1 dormakaba USA, Inc. distributor information.

Be sure that the dormakaba USA, Inc. distributor has provided the following information for each door installation:

1. dormakaba USA, Inc. ED100/ED250 Owner's Manual.
2. Review of the daily Safety information checklist (Chapter 4).
3. Instructions on how to conduct the daily Safety Information checklist by walk through example.
4. Annual compliance inspection label completion (Chapter 4).
5. Circuit breaker or disconnect location for 115 VAC power to the ED100/ED250.
6. ED100/ED250 program switch panel location and instructions in its use. (Para. 3.4).
7. Discussion of problems that could result from operator being allowed to operate after a malfunction observed.
8. Number to call for service or questions about your system if you are uncertain of any condition or situation.



WARNING

If there are any problems, discontinue door operation immediately and secure the door in a safe manner.

Call your local dormakaba USA, Inc. distributor for repair.

3.2 Knowing act

3.2.1 ANSI/BHMA standard A159.19 definition.

Consciously initiating the powered opening of a low energy door using acceptable methods including:

- Push plates.
- Fixed non-contact switches.
- Action of manually opening (pushing or pulling) a door.
- Controlled access devices such as keypads, card readers, and key switches.

3.3 Low energy power operated door

3.3.1 ANSI/BHMA standard A159.19 definition.

A door with a power mechanism that opens the door upon receipt of a knowing act signal, does not generate more kinetic energy than specified in the ANSI / BHMA A156.19 standard, and is closed by a power mechanism or other means.

3.4 Program switch panel

3.4.1 Program switch door control modes.

1. Auto, door opens when actuated by:
 - Knowing act device (Para. 3.2). Door will remain at full open position for not less than 5 seconds.
 - Push/pull actuation of door, Para. 6.1.4. Door will remain at full open position for not less than 3 seconds.
2. Auto, door opens automatically when one of the activators is actuated or triggered and closes on expiration of adjustable hold open time with no activators or actuators triggered.
3. Open, door opens automatically and remains open.
4. Close, door will remain closed, or if door is open door will close.

3.4.2 Exit Only switch modes.

- Off, interior and exterior activation sensors both active.
- On, exterior activation sensor disabled when door fully closed. Only interior activation sensor will enable door opening.

Fig. 3.4.1 Program switch panel

- 1 Program switch panel
- 2 Program switch, three position
- 3 Exit only switch, two position
- 4 Comm port for dormakaba handheld

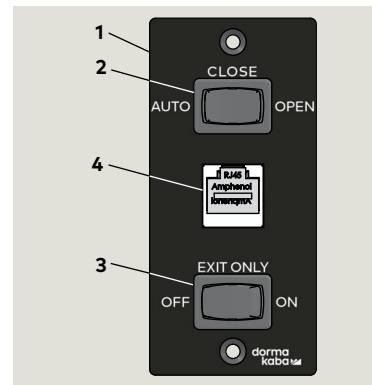

3.5 Optional key switch panels

Fig. 3.5.1 Optional key switch panels

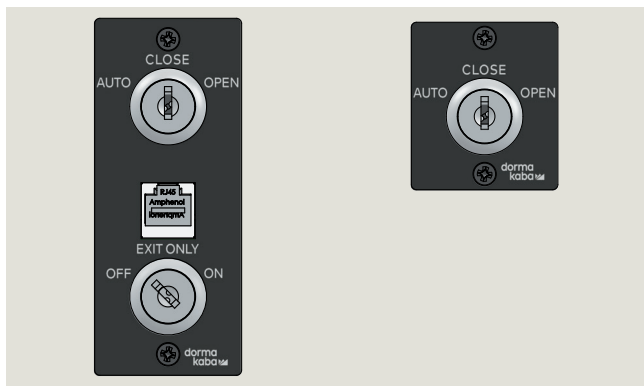

4 AAADM Safety information labels

4.1 Safety label, automatic swinging doors

4.1.1 Automatic swinging door safety information label.

This AAADM label outlines safety checks that should be performed daily on automatic swinging door controlled by an ED100 or ED250 configured for full energy.

4.1.2 Safety information label location.

Place label in a protected, visible location on door frame, near operator power switch if possible.

4.1.3 Annual compliance section of label.

This section of label is only completed on automatic swing doors that comply with ANSI/BHMA A156.10 standard and pass inspection by a AAADM certified dormakaba USA, Inc. technician.

4.1.4 Additional annual compliance inspection labels.

Place additional labels over annual compliance inspection section of safety information label.

4.2 Safety label, low energy swinging doors

4.2.1 Low energy swinging door safety information label.

This AAADM label outlines safety checks that should be performed daily on low energy swinging door controlled by an ED100 or ED250 operator configured for low energy.

4.2.2 Safety information label location.

Place label in a protected, visible location on door frame, near operator power switch if possible.

4.2.3 Annual compliance section of label.

This section of label is only completed on low energy swing doors that comply with ANSI/BHMA A156.19 standard and pass inspection by a AAADM certified dormakaba USA, Inc. technician.

4.2.4 Additional annual compliance inspection labels.

Place additional labels over annual compliance inspection section of safety information label.

Fig. 4.1.1 Safety information labels

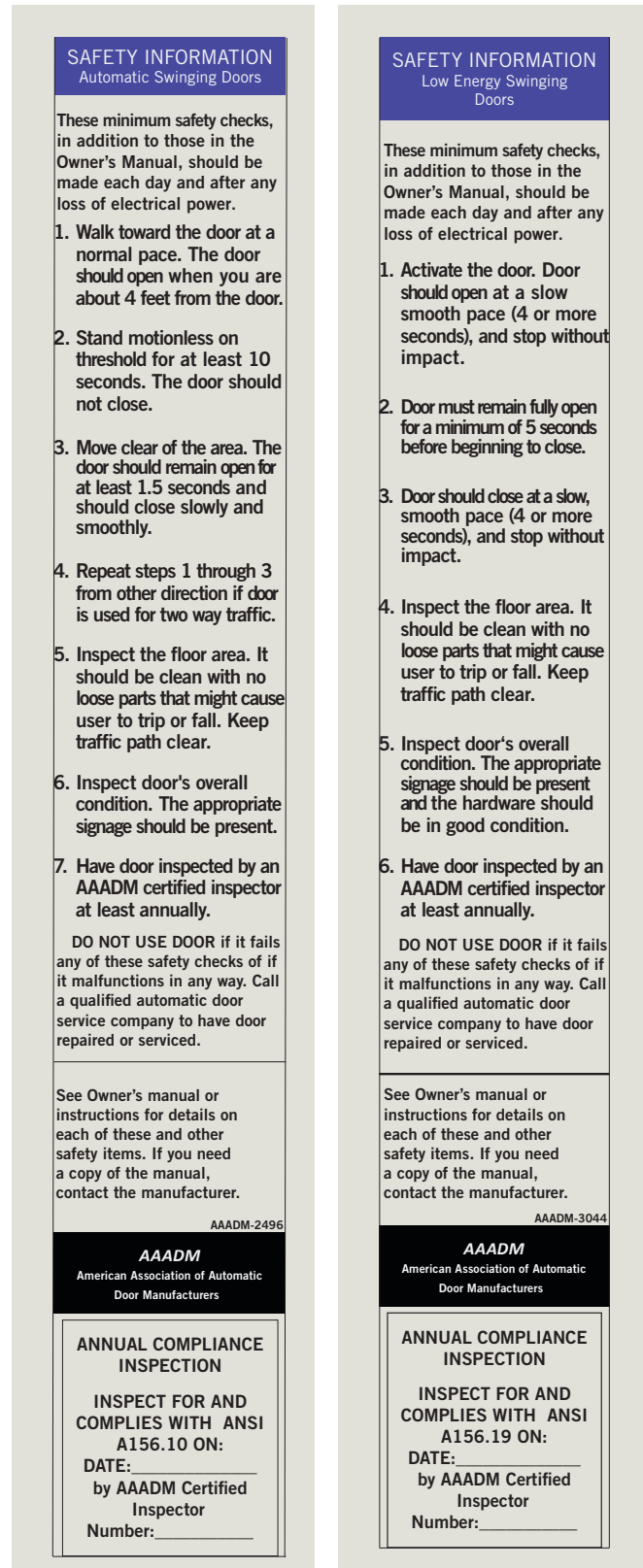
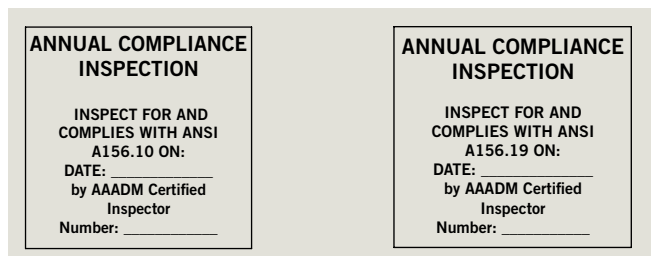

Fig. 4.1.2 Annual compliance inspection labels



5 Daily safety check procedure

5.1 Power operated swing doors

NOTICE

All figures and diagrams are for purposes of illustration only and are from AAADM automatic swinging door manual, reprinted with permission.

5.1.1 Performing daily safety checks

Perform safety checks daily on your automatic swinging door to insure your customer and employee safety. The daily safety checks are listed in Chapter 4, Safety Information labels.

TIPS AND RECOMMENDATIONS

Perform these checks while traffic is restricted from all detection and sensing zones.

5.1.2 Sensor activation, presence detection safety

1. Check activation sensor by walking toward door opening at moderate speed, door should:
 - Start opening when you are about four feet from door.
 - Open smoothly.
 - Stop at fully open without impact.
2. Move slowly through door opening (approximately six inches/second) stop in door swing path, and pause for ten seconds.
 - Door should remain open.
3. If two way traffic, repeat from other side of door.
4. Step out of sensor zone activating area.
 - After a brief delay (minimum 1.5 seconds) door should close smoothly and without impact.
5. For one way traffic, approach safety side of door and have someone else approach activating side.
 - Door equipped with overhead mounted presence sensor (Fig 5.1.1), as long as you are in safety area of door it should not open.
 - Door equipped with door mounted presence sensors (Fig 5.1.2), door may start to open but should reverse, stop or slow down.
6. Stand motionless in door for at least 4 seconds.
 - Door equipped with overhead mounted presence sensor (Fig 5.1.1), door should not close.
 - Door equipped with door mounted presence sensors (Fig 5.1.2), door may start to close but should reverse, stop or slow down.

Fig. 5.1.1 One way traffic, overhead mounted presence sensor

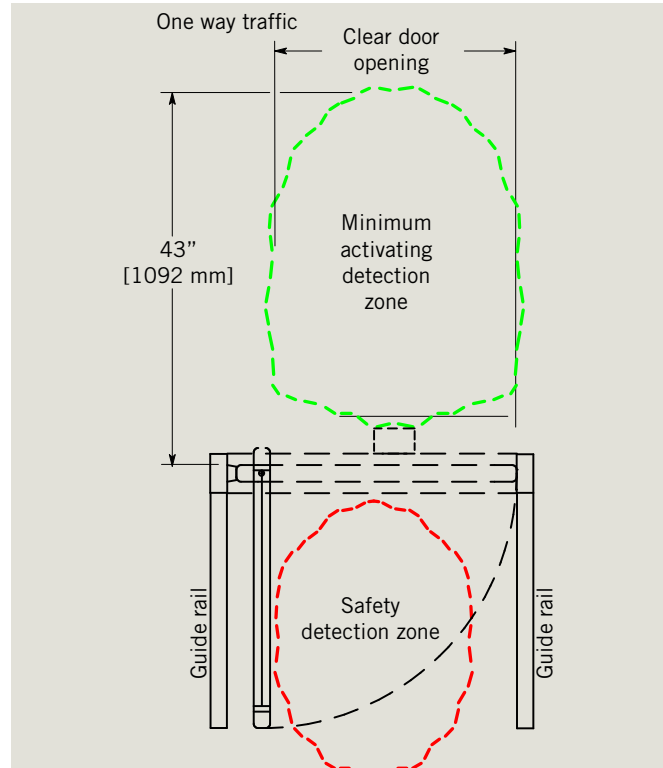

Fig. 5.1.2 One way traffic, door mounted presence sensors



5.1.3 Double egress knowing act switch activation

1. Double egress doors are commonly activated by knowing act switch(es).
2. Operate knowing act device, doors should:
 - Open smoothly and stop at fully open without impact.
 - Remain open for a minimum of five seconds before closing.
3. As door closes, approach door from approach side:
 - Door should reopen.
4. Continue across threshold and stand motionless for 10 seconds:
 - Door should not contact you.
5. Continue through door, the door should:
 - Start closing after a minimum of five seconds.
 - Close smoothly and without impact.
6. Approach safety zone side of door:
 - If door equipped with overhead presence sensor (Fig. 5.1.3) door should not open as long as you are in safety zone when door closed.
 - If door equipped with door mounted presence sensor (Fig. 5.1.4) door may start to open but should reverse, stop or slow down.

Fig. 5.1.3 Double egress, overhead presence sensors

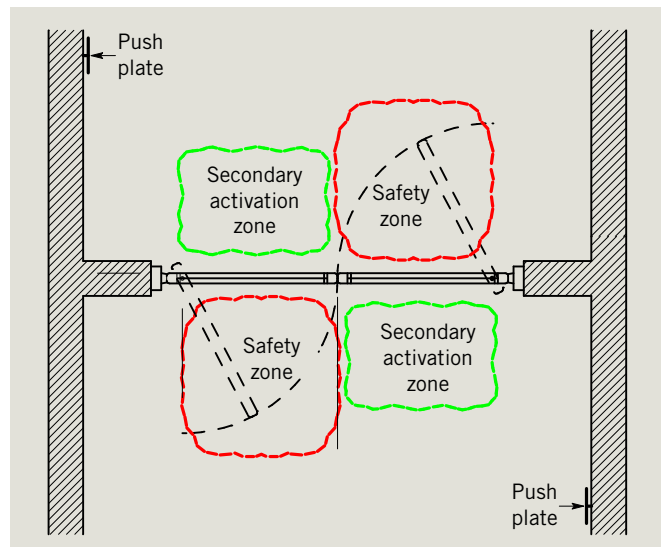
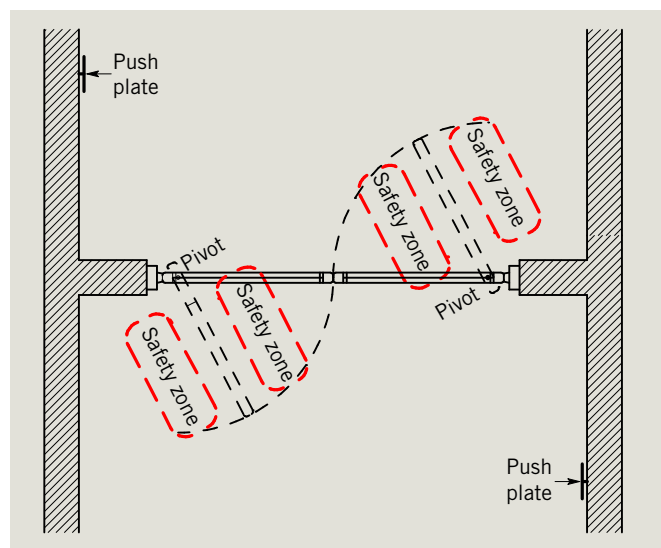

Fig. 5.1.4 Double egress, overhead presence sensors



5.2 Low energy power operated swing doors

5.2.1 Performing daily safety checks

Perform safety checks daily on your low energy swing door to insure your customer and employee safety. These daily safety checks are also listed in Chapter 4, Safety Information labels, low energy swinging doors.

1. Activate the door by a knowing act (Para.3.3).
 - Door should open at a slow smooth pace (4 seconds or more) and stop without impact.
2. Door must remain fully open for a minimum of 5 seconds before beginning to close.
 - Door should close at a slow smooth pace (4 seconds or more) and stop without impact.
3. Inspect the floor area, it should be kept clean with no loose parts that might cause user to trip or fall. Keep traffic path clear.

4. Inspect door's overall condition. The appropriate signage (Chapter 7) should be present and all hardware should be in good condition.
5. Have door inspected by a dormakaba USA Inc. AAADM certified technician at least annually.



WARNING

If there are any problems, discontinue door operation immediately and secure the door in a safe manner. Call your local dormakaba USA Inc. distributor for repair.

6 General safety related items

6.1 Power operated swing doors

6.1.1 Review safety related items and perform checks periodically as noted.



TIPS AND RECOMMENDATIONS

Perform these checks while traffic is restricted from all detection and sensing zones.

1. Housekeeping
 - Check door area for tripping or slipping hazards.
 - Check all doors for damage.
 - Make sure all hardware and overhead covers are properly secured.
 - There should be no bulletin boards, literature racks, merchandise displays, or other attractions in the door area that would interfere with the use of the door or encourage people to stop and stand in the door area.
2. Door closing force
 - Force to prevent the door from closing should not exceed 30 pounds measured with a force gauge.
3. Door safety signage
 - Refer to Chapter 7 for door safety signage requirements.
 - Refer to Chapter 4 for Safety Information labels.
4. Activating switch, knowing act (Para. 3.2)
 - Doors equipped with a manual activating switch shall hold door fully open for a minimum of five seconds before closing.
5. Guide rails (Fig. 6.1.1, 2), if used.
 - Check that guide rails or other barriers or separators are present (two per swing door side) and firmly anchored.
 - Rail lengths should be the width of the open door or greater.
6. Lock stile
 - With door open, grasp lock stile of door and attempt to move horizontally and vertically.
 - There should be no looseness in the door pivots or in connections between door and operator.

Fig. 6.1.1 Guide rails, jamb and floor mounted

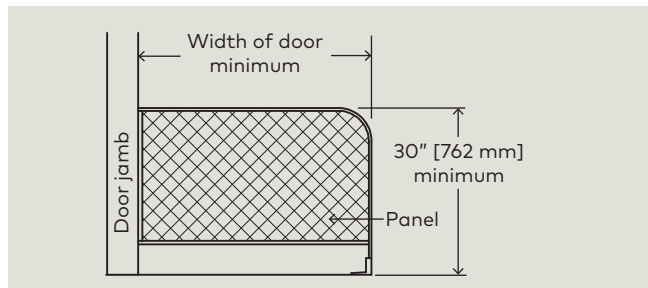
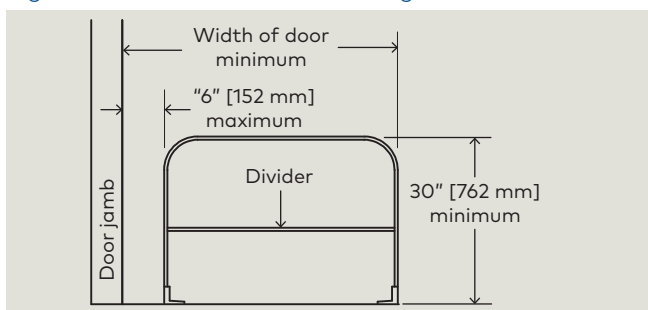

Fig. 6.1.2 Guide rails, free standing, floor mounted



7. Breakout stop
 - Center pivoted in swinging doors may be supplied with an emergency breakout stop or switch that will allow the door to open in the direction of emergency egress.
 - When the door is pushed into the breakout mode, check that the door will not activate.
8. Traffic patterns
 - Observe traffic patterns. Plan routing so people enter and exit in a straight approach, directly toward the door opening.
9. Finger guard
 - If installed, inspect finger guard to see that it is secure and in good repair.
10. AAADM safety information label (Chapter 4)
 - An AAADM safety information label should be affixed on the door or door frame in a protected, visible location.
 - If you need additional decals or labels, contact your local authorized dormakaba USA, Inc. distributor.



WARNING

If there are any problems, discontinue door operation immediately and secure the door in a safe manner.
Call your local dormakaba USA, Inc. distributor for repair.

6.2 Low energy power operated swing doors

6.2.1 Review safety related items and perform checks periodically as noted



TIPS AND RECOMMENDATIONS

Perform these checks while traffic is restricted.

1. Housekeeping
 - Check door area for tripping or slipping hazards.
 - Make sure all hardware and overhead covers are properly secured.
 - There should be no bulletin boards, literature racks, merchandise displays, or other attractions in the door area that would interfere with the use of the door or encourage people to stop and stand in the door area.
2. Check all doors for damage.
3. Door closing force
 - Force to prevent the door from closing should not exceed 15 pounds measured with a force gauge.
4. Door safety signage
 - Refer to Chapter 7 for door safety signage requirements. Chapter 4 documents safety information (daily safety check) and annual compliance inspection labels requirements.
5. Lock stile
 - With door open, grasp lock stile of door and attempt to move horizontally and vertically.
 - There should be no looseness in the door pivots or in connections between door and operator.
6. Breakout stop
 - Center pivoted in swinging doors may be supplied with an emergency breakout stop or switch that will allow the door to open in the direction of emergency egress.
 - When the door is pushed into the breakout mode, check that the door will not activate.



WARNING

If there are any problems, discontinue door operation immediately and secure the door in a safe manner.

Call your local dormakaba USA, Inc. distributor for repair.

7 ED100/ED250 door signage

7.1 Full energy operator

7.1.1 Overview

Signage and warnings are specified in ANSI /BHMA A156.10, American National Standard for power operated pedestrian doors, paragraph 11.

7.1.2 Door, one way traffic

Fig. 7.1.1 One decal, approach, non-approach

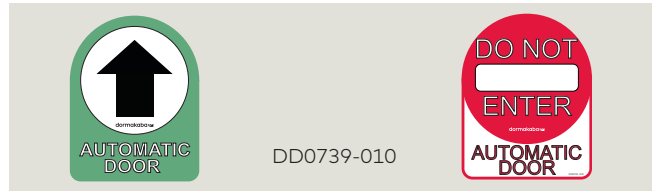

1. Arrow and AUTOMATIC DOOR, one side of decal.
 - Shall be visible from approach side of a swinging door, mounted on door at a height of 50" ± 12" from floor to centerline of sign.
2. DO NOT ENTER and AUTOMATIC DOOR, one side of decal (or separate decal for solid doors).
 - Shall be visible from non-approach side of door that swings towards pedestrians attempting to travel in wrong direction.

7.1.3 Door, two way traffic

Fig. 7.1.2 One decal, non-swing, swing side

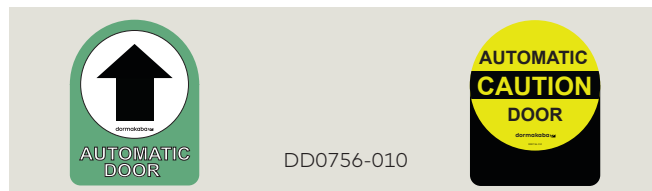

1. Arrow and AUTOMATIC DOOR, one side of decal.
 - Shall be visible from approach side of a swinging door, mounted on door at a height of 50" ± 12" from floor to centerline of sign.
2. CAUTION AUTOMATIC DOOR, one side of decal.
 - Swinging doors serving both egress and ingress shall have a "CAUTION AUTOMATIC DOOR" sign visible from swing side of door.
 - Sign shall be mounted on door at a height of 50 ± 12" from floor to centerline of sign.

7.1.4 Knowing act door

Fig. 7.1.3 ACTIVATE SWITCH TO OPERATE decal

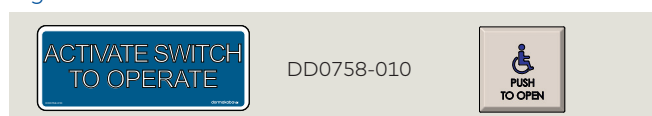

1. ACTIVATE SWITCH TO OPERATE decal.
 - Knowing act doors shall have signage stating "ACTIVATE SWITCH TO OPERATE" on side of door having knowing act switch or other knowing act device.

7.2 Low energy operator

7.2.1 Overview

Signage and warnings are specified in ANSI /BHMA A156.19, American National Standard for power assist and low energy power operated doors.

7.2.2 All low energy doors.

Fig. 7.2.1 AUTOMATIC CAUTION DOOR decal

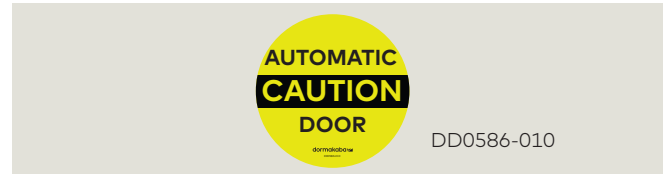

1. AUTOMATIC CAUTION DOOR decal.
 - All low energy doors shall be marked with signage visible from both side of door with the words "AUTOMATIC CAUTION DOOR".
 - Signs shall be mounted 50" ± 12" from floor to centerline of sign.

7.2.3 Knowing act switch used to initiate door operation.

Fig. 7.2.2 ACTIVATE SWITCH TO OPERATE decal

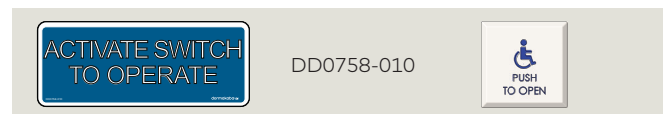

1. ACTIVATE SWITCH TO OPERATE decal.
 - When a knowing act device is used to initiate operation of door operator, door shall be provided with sign on each side of door where switch is operated with message "ACTIVATE SWITCH TO OPERATE".

7.2.4 Push/Pull used to initiate door operation.

Fig. 7.2.3 PUSH TO OPERATE, PULL TO OPERATE decals

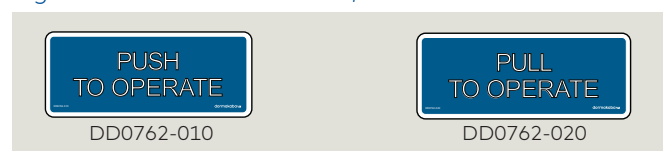

1. PUSH TO OPERATE, PULL TO OPERATE decals.
 - When push/pull is used to initiate operation of door operator, doors shall be provided with the message "PUSH TO OPERATE" on push side of door and "PULL TO OPERATE" on pull side of door.

7.3 Door signage, full energy single swing door

Fig. 7.3.1 One decal, one way traffic
Approach



Fig. 7.3.2 One decal, two way traffic
Non-swing side Swing side



7.4 Door signage, low energy single swing doors, initiation of door operation

Fig. 7.4.1 Knowing act device

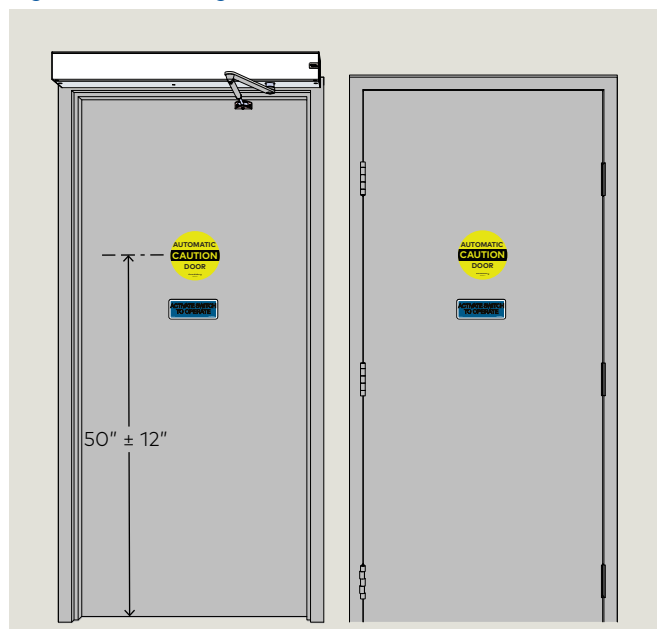
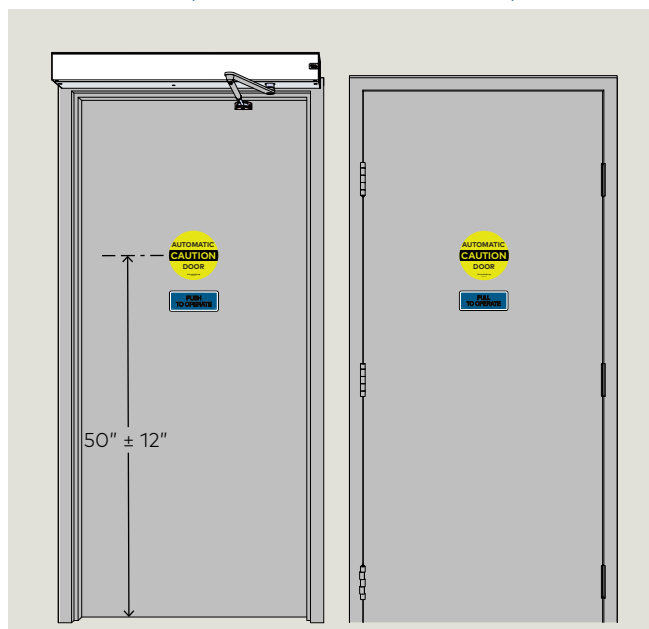

Fig. 7.4.2 Push/Pull
Push To Operate Pull To Operate



7.5 Door signage, full energy double swing doors

Fig. 7.5.1 One way traffic, approach side

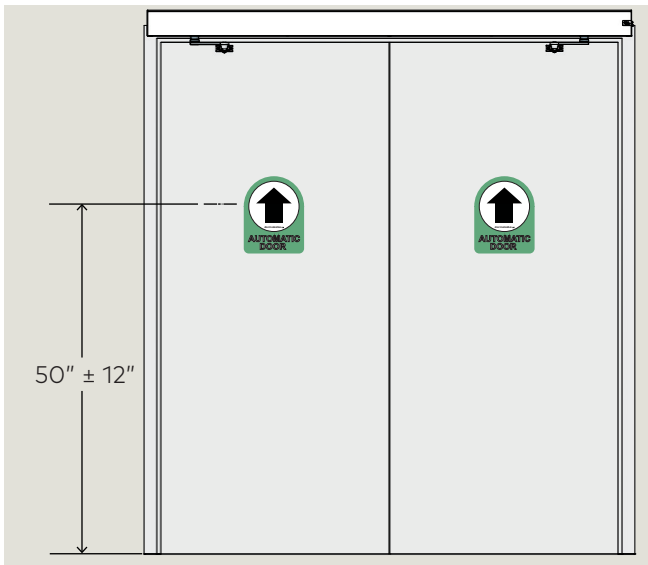

Fig. 7.5.2 One way traffic, non-approach side

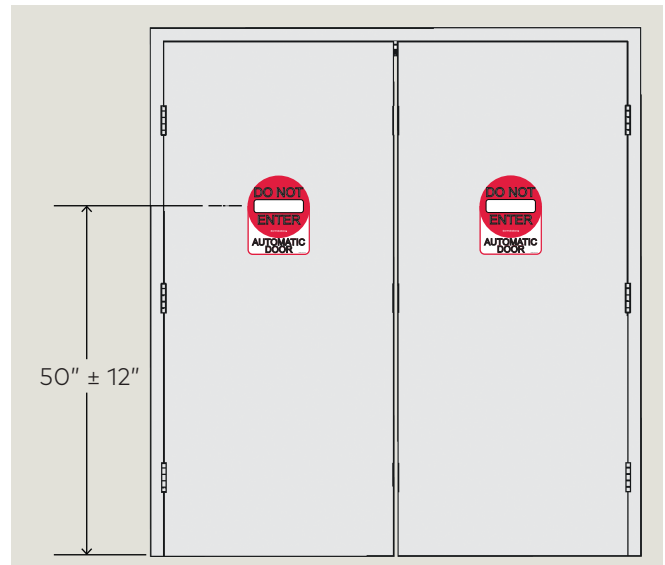

Fig. 7.5.3 Two way traffic, non-swing side

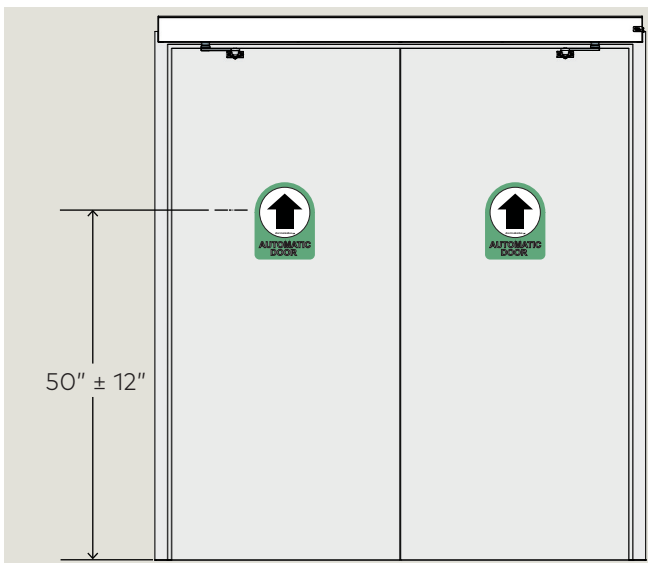

Fig. 7.5.4 Two way traffic, swing side

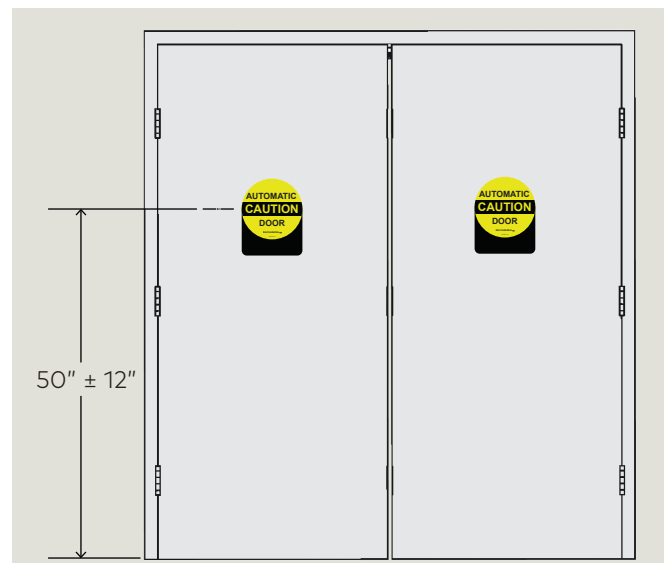

Fig. 7.5.5 One way traffic, knowing act, approach side

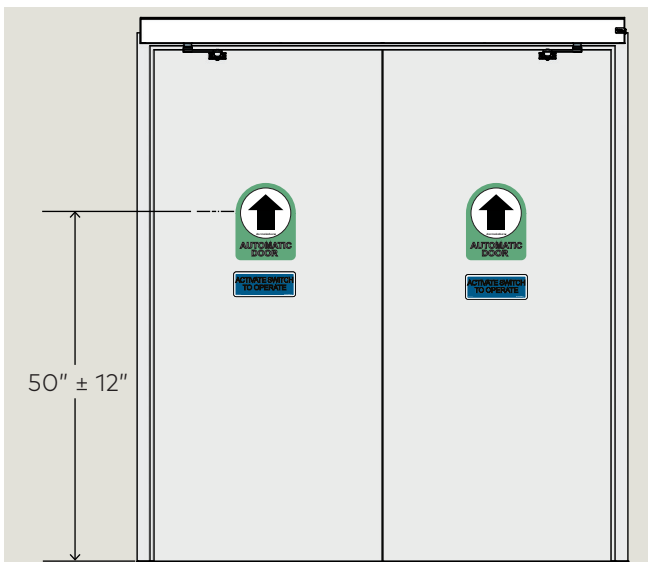

Fig. 7.5.6 One way traffic, knowing act, non-approach side

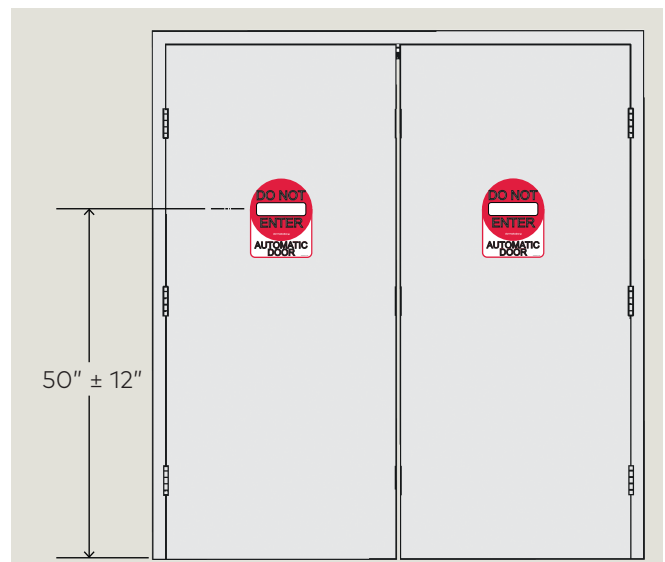

Fig. 7.5.7 Double egress, RH, one way traffic, interior

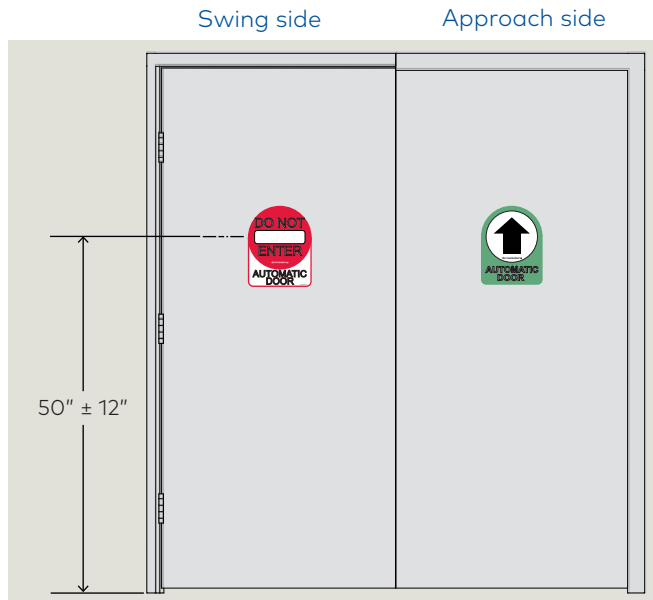

Fig. 7.5.8 Double egress, RH, one way traffic, exterior

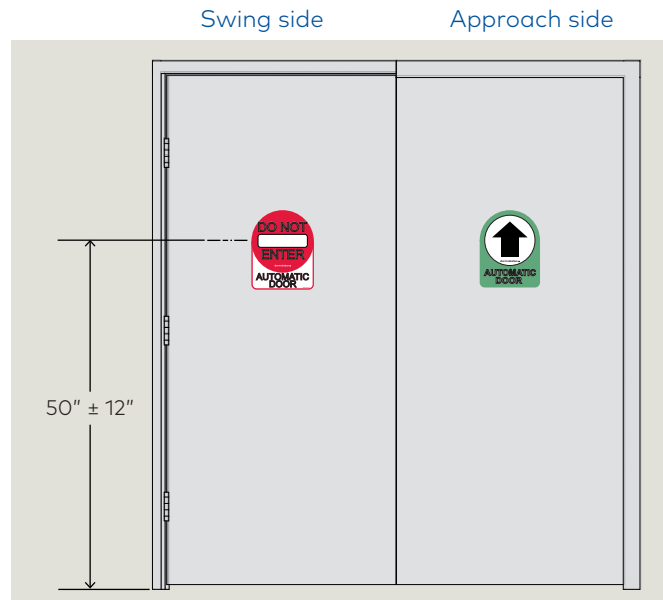

Fig. 7.5.9 Double egress, LH, two way traffic, interior

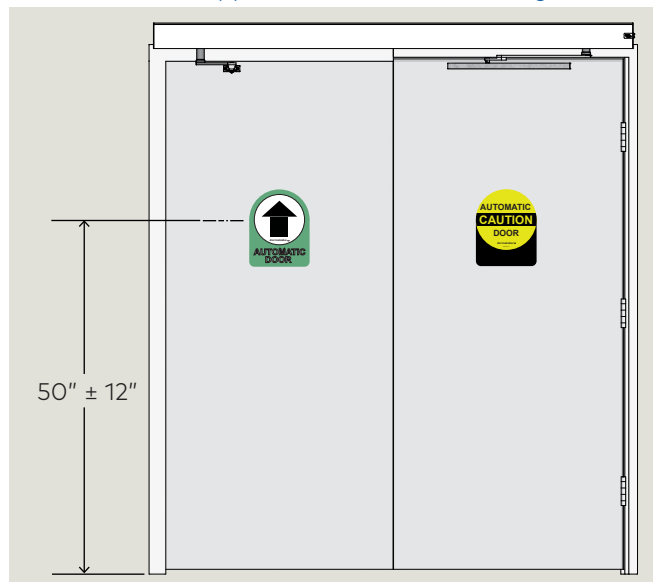
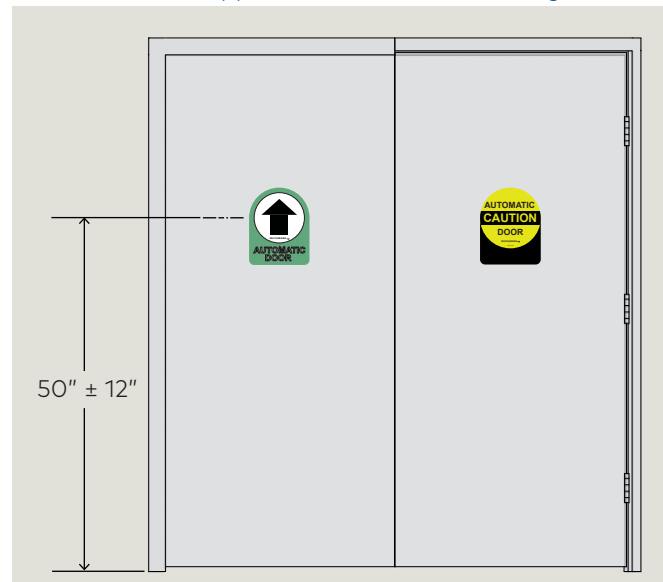

Fig. 7.5.10 Double egress, LH, two way traffic, exterior



7.6 Door signage, low energy double swing doors

Fig. 7.6.1 Knowing act, non-hinge side



Fig. 7.6.2 Knowing act, hinge side

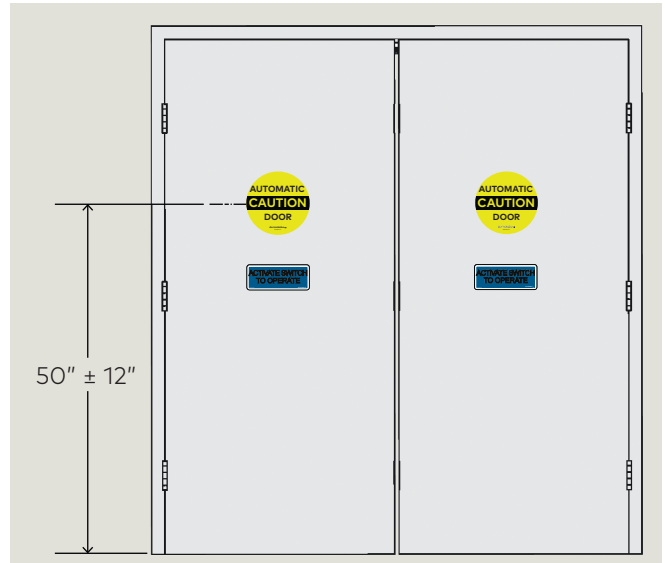

Fig. 7.6.3 Push/Pull, Push to operate



Fig. 7.6.4 Push/Pull, Pull to operate

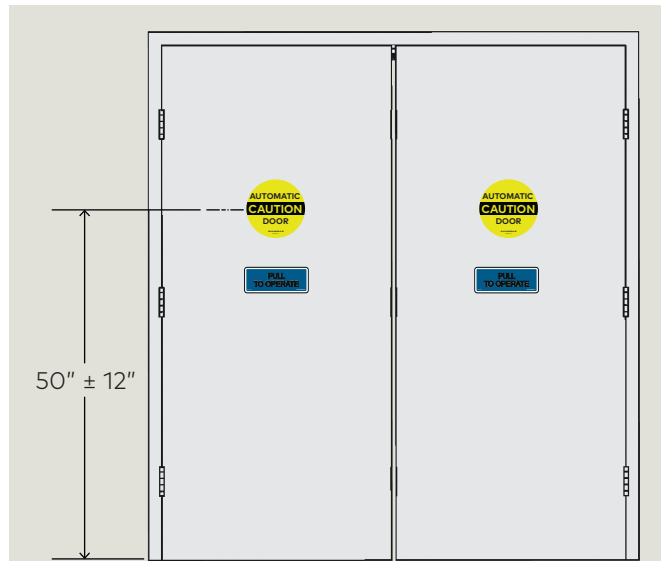

Fig. 7.6.5 Double egress, RH, knowing act

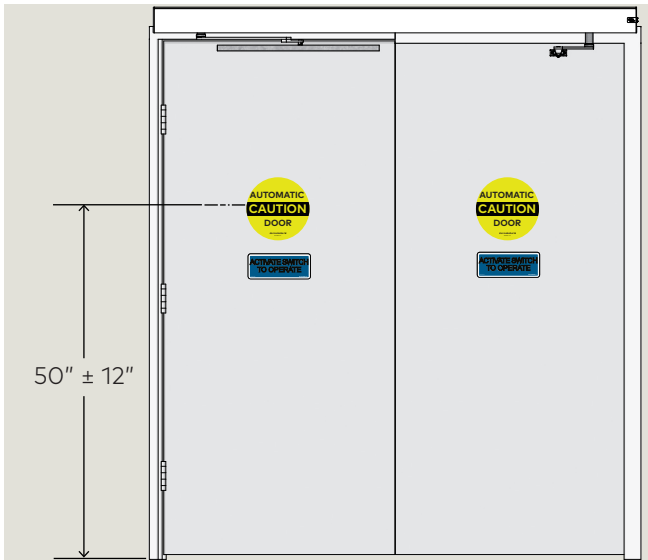
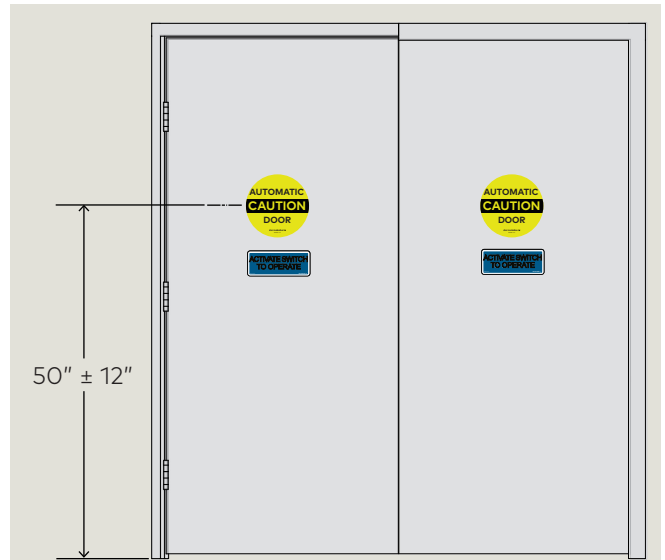

Fig. 7.6.6 Double egress, RH, knowing act



8 ED100/ED250 header cleaning

8.1 ED100/ED250 environment and cleaning

Table 8.3.1 Operator environmental requirements

Ambient temperature	5 to 122 °F
Suitable for dry rooms only	Relative air humidity: 93% maximum, non-condensing

Fig. 8.3.1 ED100/ED250 header

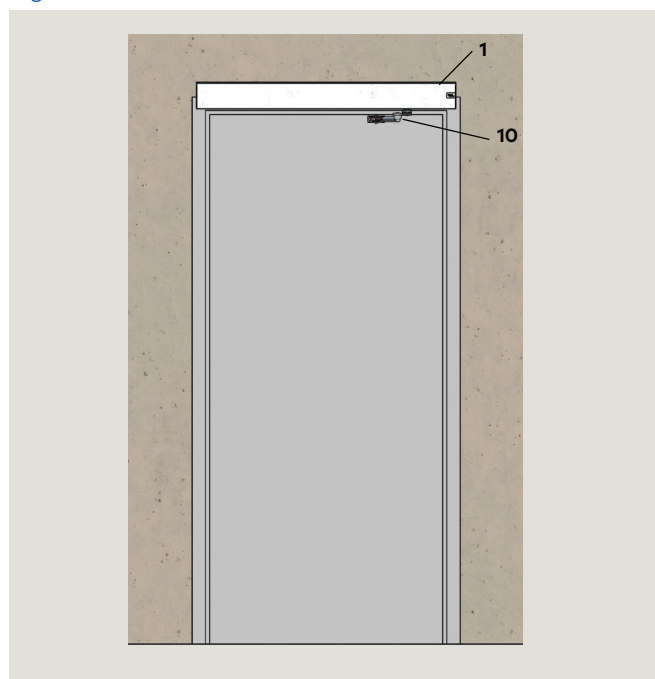

8.1.1 ED100/ED250 environmental requirements.

ED100/ED250 header assembly is designed to operate on an interior building surface under the specifications shown in Table 8.3.1.

8.1.2 Areas around door(s) and door swing radius.

Areas around doors and door swing radius must be kept clear of all obstacles.

8.1.3 Cleaning



WARNING

Cleaning of header surfaces must be done with program switch (Para. 3.4) in Close position!

External surfaces of the header can be cleaned with a damp cloth and commercial cleaning agents.



TIPS AND RECOMMENDATIONS

Abrasive (scouring) agents should not be used as they may damage external surfaces.

8.1.4 Water and other liquids

CAUTION

No water or other liquids must be sprayed or spilled on ED100/ED250 header!

